

54-7393-01

THIS INFORMATION IS UP TO DATE AS OF NOVEMBER, 1982

SERVICE AND OPERATION MANUAL G08-105 X-Y COLOUR MONITOR

TABLE OF CONTENTS

Description	Page
G08-105 Model	1
Service Data Reference	2
Warnings	2
Operating Instructions	3
Performance and Operating Data	3
Product Safety and Guidelines	4
Service Set-Up Procedure	5-7
CRT P.C.B. Component Layout	8
EHT P.C.B. Component Layout	8
X-Y P.C.B. Component Layout	9
Notes	10
Schematic	11

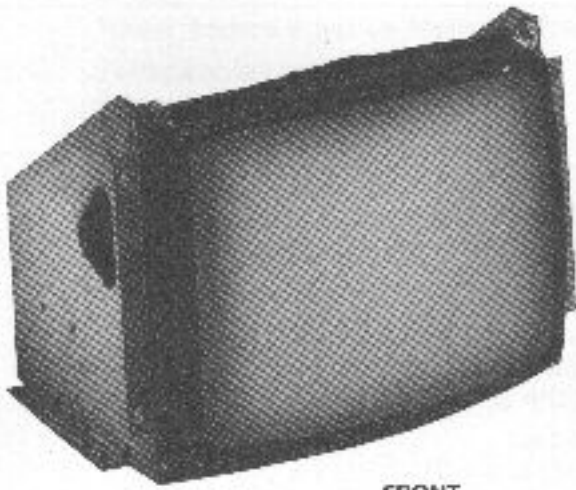

FRONT

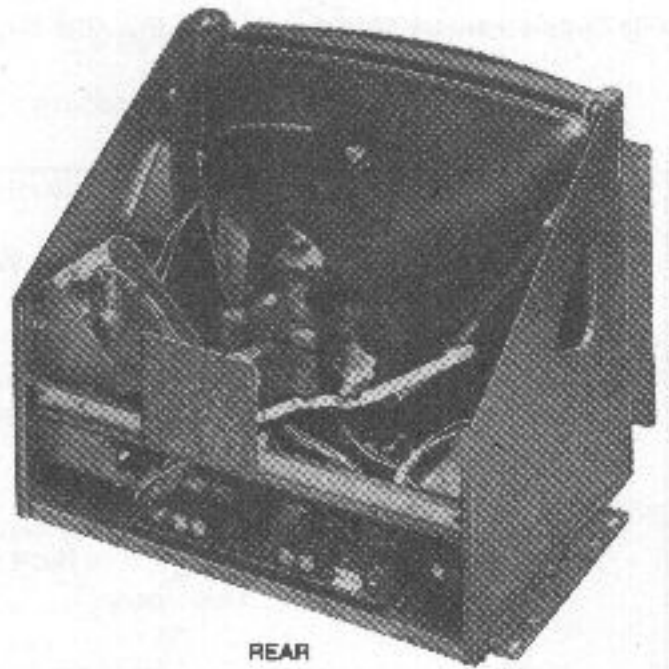

REAR

G08-105

NOTES

Service Data Reference

When writing for Service Information, please quote chassis type number and model code. See chassis type number and model code located on the right hand side panel.
This information is correct as of November 1982.

File Supplementary Model Data with this G08 Manual.

Warnings

1. Power Up Warning

Caution: If the monitor is to be powered up outside of the games console, an isolation transformer providing the correct AC voltages must be used for the AC power source.

2. X-Radiation

This chassis has been designed for minimal x-radiation hazard. However, to avoid possible exposure to soft x-radiation it is IMPERATIVE that the EHT circuitry IS NOT modified.

3. High Voltage

The colour monitor contains HIGH VOLTAGES derived from power supplies capable of delivering LETHAL quantities of energy. To avoid DANGER TO LIFE, do not attempt to service the chassis until all precautions necessary for working on HIGH VOLTAGE equipment have been observed.

4. CRT Handling

The picture tube encloses a high vacuum and due to the large surface area is subject to extreme force. Care must be taken not to bump or scratch the picture tube as this may cause the tube to implode resulting in personal injury and property damage. Shatter-proof goggles must be worn by individuals while handling the CRT or installing it in the monitor. Do not handle the CRT by the neck.

5. To prevent fire or shock hazard DO NOT EXPOSE THIS MONITOR TO RAIN OR MOISTURE.

Operating Instruction

1. Apply a suitable power source through an isolation transformer, providing correct AC voltage, by means of P400.
2. Apply a suitable signal source to the monitor P.C.B. by means of P100.

Performance and Operating Data

1.0 Supply

Power Source must be from a C.T. isolation transformer of 91 vac nominal

Voltage measured at test point 1 (See Fig. 1) under all condition.

Min	Max
+52VDC	+70VDC

Frequency

50 Hz	60 Hz
-------	-------

2.0 High Voltage (EHT)

For 19" V Models

21.0 K	22 K
--------	------

NOTE: Condition Above
I (Beam) = 0

3.0 Pin Assignment for P100

Pin No.	Description	Impedance	Signal Level
1	H. Input (X)	2K	± 4V
2	V. Input (Y)	2K	± 3V
3	GND		
4	Red Input	2K7	0-+4V
5	Green Input	2K7	0-+4V
6	Blue Input	2K7	0-+4V

4.0 Service Set Up Control

NOTE: These controls have been factory adjusted. If adjustment is necessary check set up procedure in this manual.

4.1	G2 Adjustment	R930
4.2	Vert. Cent.	R605
4.3	Hori. Cent.	R712
4.4	Height	R611
4.5	Width	R702
4.6	Crt. Cut Off Control (See Fig. 3)	
	Red Cutoff	R107
	Green Cutoff	R118
	Blue Cutoff	R136
4.7	Video Drive Control (See Fig. 3)	
	Red Drive	R106
	Green Drive	R117
4.8	EHT Duty Cycle	R918
4.9	EHT Frequency Adj.	R917
4.10	EHT Sensing Control	R933
4.11	EHT Regulator Adjustment	R945

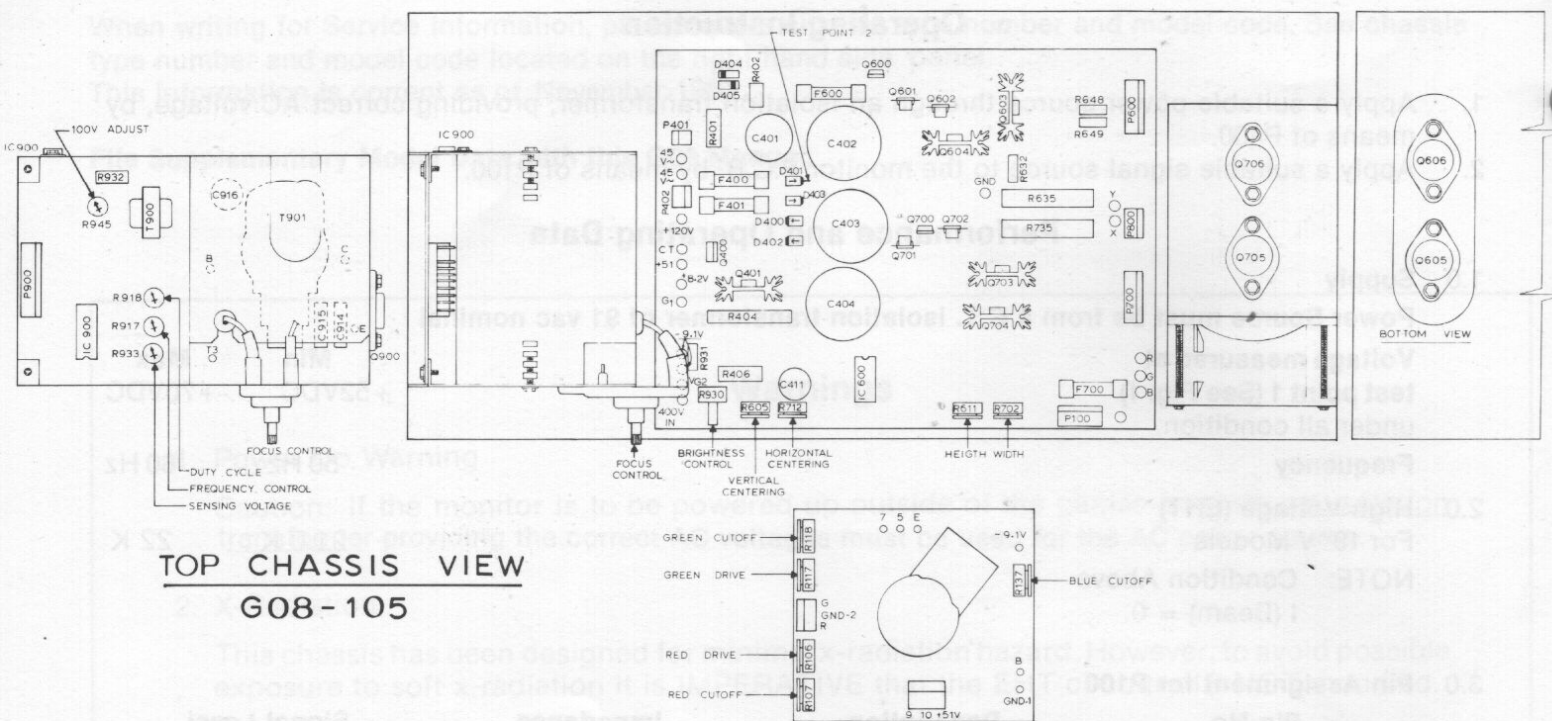

Figure 1

Product Safety and Servicing Guidelines

Safety Checks

Subject: Fire and Shock Hazard

1. No modification of any circuit should be attempted. Service work should be performed only after you are thoroughly familiar with all of the following safety checks and service guidelines. To do otherwise increases the risk of potential hazards and injury to the user.
2. When service is required, observe the original lead dress. Extra precaution should be given to assure correct lead dress in the high voltage circuitry area. Where a short circuit has occurred, replace those components that indicate evidence of overheating. Always use the manufacturer's specified replacement component. See parts list in the back of this manual.
3. Periodically check the high voltage for proper value using a meter of known accuracy and calibration.
4. Check for frayed insulation on wires.

Service Set-Up Procedure

NOTE: All monitors are equipped with automatic degaussing coils which effectively demagnetize the picture tube each time the monitor is turned on. The degaussing coils will operate any time the set is turned on after having been off for at least five minutes.

The degaussing effect is confined to the picture tube since the coils are mounted on the ferrous tube shield. Should any part of the chassis or cabinet become magnetized, it will be necessary to degauss the affected area by means of a manual degaussing coil. Move the coil slowly around all monitor surface areas then slowly withdraw for a distance of six feet before disconnecting the coil from the AC power supply.

Normally little, if any adjustment should be necessary. However, when a picture tube, yoke or similar component is replaced, preliminary static convergence should be done before attempting purity adjustment, and so on.

Set up should be done in a north/south direction. Horizontal and vertical centering taps should be set to the centre position if a major component has been changed.

1.0 Purity

- 1.1 Loosen yoke clamp screw and positioning screw. Remove adhesive material from positioning screw. (Figure 2).
- 1.2 A small quantity of "nail polish" has been used to lock the purity convergence rings in place. This seal must be broken with a sharp tipped instrument before any adjustments are attempted. It goes without saying that upon completion of all adjustments, a dab of paint or nail polish must be re-applied to edge of rings to prevent movement.
- 1.3 Connect an appropriate signal source, eg: Electro-home X-Y generator producing a white field plus individual red, green and blue fields.
- 1.4 Move the tabs of each of the ring magnets: (purity magnets, 4 pole convergence magnets and 6 pole convergence) together as shown in figure 3. (See figure 2 for location of ring magnets).
- 1.5 Turn off the red and blue fields on the generator and adjust the G2 control (figure 1) to produce a green field.
- 1.6 Pull the deflection yoke back so that a green band appears in the centre of the screen.
- 1.7 Spread the tabs of the purity magnets apart as little as necessary and rotate both rings together to center the green band horizontally on the face of the CRT (See Fig. 4).
- 1.8 Slide the yoke towards the bell of the picture tube slowly to obtain a uniform green field (pure in color) across the entire tube face. Juggle back and forth slightly as necessary. Lightly tighten yoke retaining clamp.
- 1.9 Momentarily switch on a cross-hatch signal and rotate yoke to level the pattern on the face of CRT.
- 1.10 Return generator to regain green raster.
- 1.11 Turn off green field and check for pure field for each of the red and blue fields. Reposition yoke if necessary to obtain optimum purity on all fields.
- 1.12 Tighten yoke clamp screw to prevent yoke shift or rotation. (Do not tighten positioning screws at this time.)

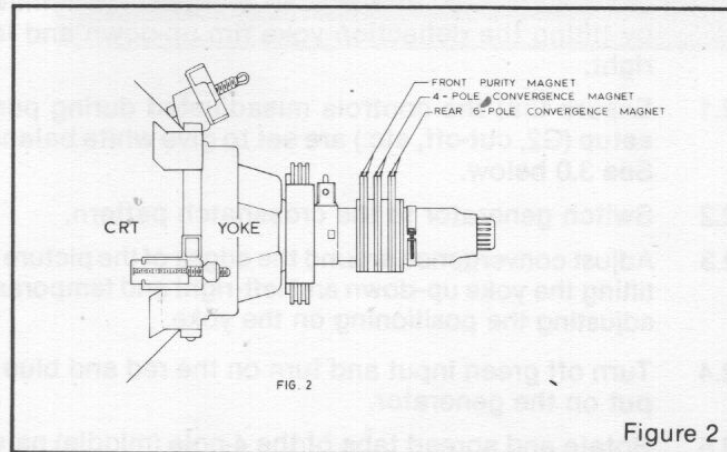

Figure 2

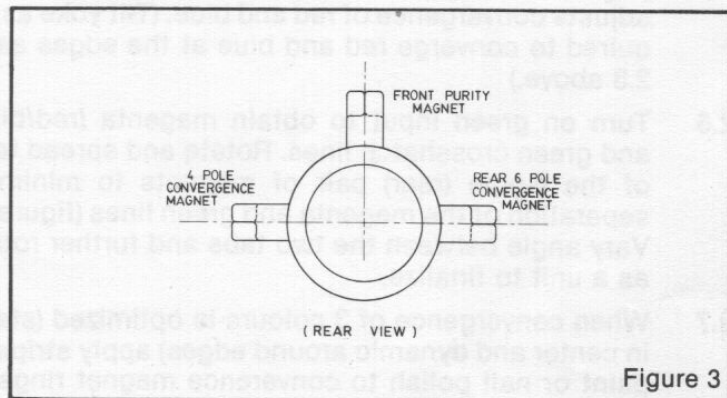

Figure 3

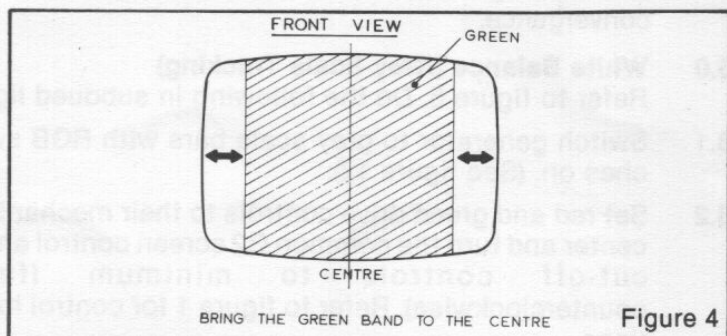

Figure 4

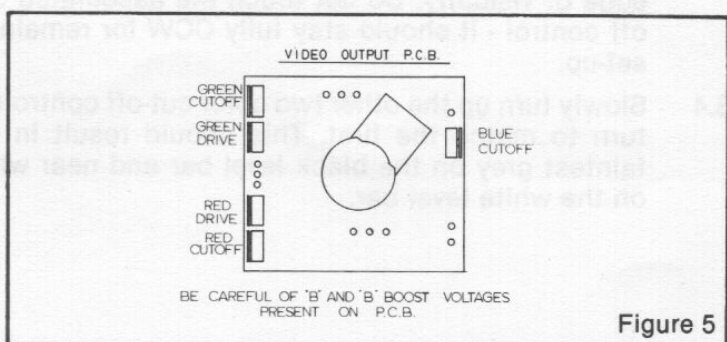

Figure 5

2.0 Static and Dynamic Convergence

NOTE: Static convergence is achieved by 2 sets of ring magnets located on the neck, nearest the base of the picture tube, Fig. 2. The 4 pole magnetic rings are adjusted to converge the blue and red crosshatch lines. The 6 pole convergence rings (closest to the base of the picture tube) are adjusted to converge the magenta (blue/red) to the green crosshatch lines. Dynamic convergence is achieved by tilting the deflection yoke rim up-down and left-right.

2.1 Ensure that the controls misadjusted during purity setup (G2, cut-off, etc.) are set to give white balance. See 3.0 below.

2.2 Switch generator to the crosshatch pattern.

2.3 Adjust convergence around the edges of the picture by tilting the yoke up-down and left-right and temporarily adjusting the positioning on the yoke.

2.4 Turn off green input and turn on the red and blue input on the generator.

2.5 Rotate and spread tabs of the 4-pole (middle) pair of magnets to minimize separation of the red and blue crosshatch lines around the center of the screen (Figure 6). Variation of the angle between the tabs adjusts convergence of red and blue. (Tilt yoke as required to converge red and blue at the edges as in 2.3 above.)

2.6 Turn on green input to obtain magenta (red/blue) and green crosshatch lines. Rotate and spread tabs of the 6-pole (rear) pair of magnets to minimize separation of the magenta and green lines (figure 7). Vary angle between the two tabs and further rotate as a unit to finalize.

2.7 When convergence of 3 colours is optimized (static in center and dynamic around edges) apply stripe of paint or nail polish to convergence magnet rings to prevent movement.

2.8 Tilt yoke, by adjusting positioning screw, in up-down and left-right direction for best circumference convergence.

3.0 White Balance (Grey Scale Tracking)

Refer to figure 5. Do the following in subdued light:

3.1 Switch generator to grey scale bars with RGB switches on. (See figure 12).

3.2 Set red and green drive controls to their mechanical center and turn the common G2 screen control and 3 cut-off controls to minimum (fully counterclockwise). Refer to figure 1 for control locations.

3.3 Slowly turn up G2 screen control until the first faint color appears at black level bar, then back off to edge of visibility. Do not touch the associated cut-off control - it should stay fully CCW for remaining set-up.

3.4 Slowly turn up the other two color cut-off controls in turn to match the first. This should result in the faintest grey on the black level bar and near white on the white level bar.

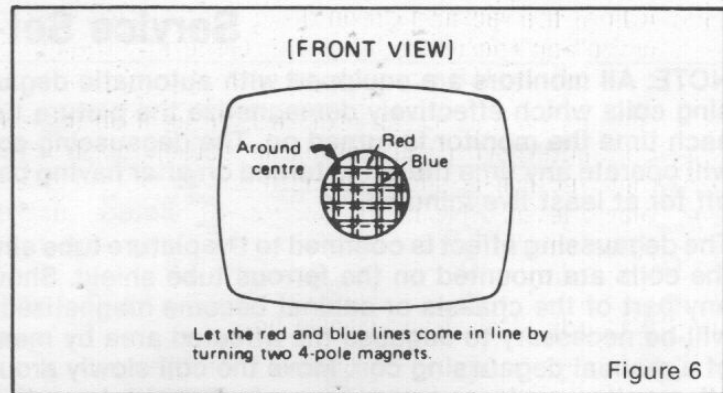

Figure 6

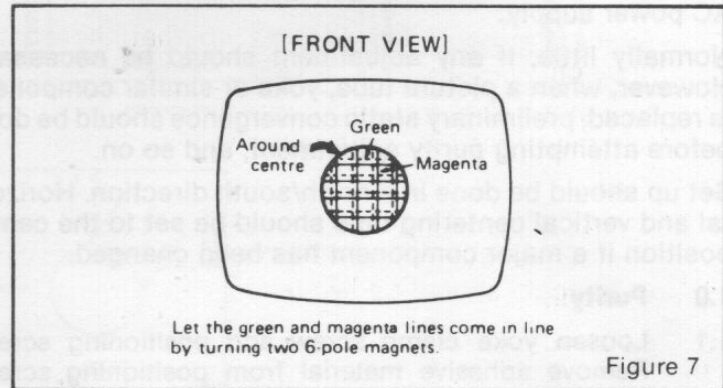

Figure 7

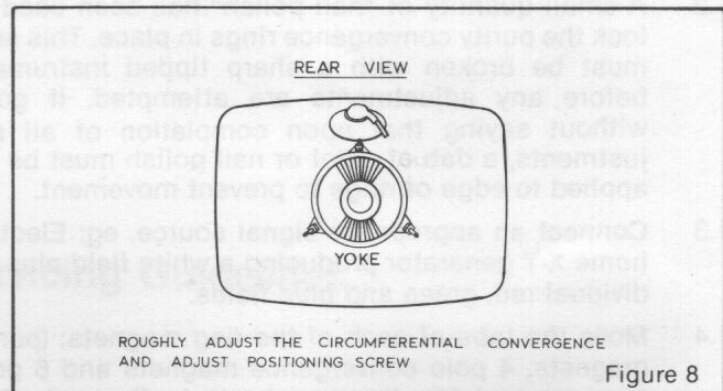

Figure 8

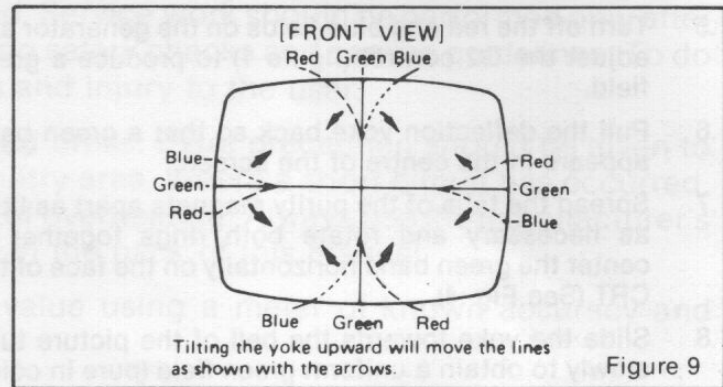

Figure 9

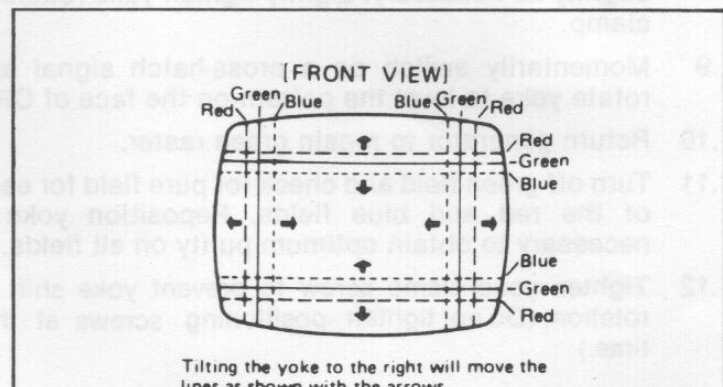

Figure 10

3.5 Adjust the red and green drive controls for "neutral white" on the white level bar. Generally these controls will be left at mech. centre.

3.6 Repeat 3.4 and 3.5 as required. When monitor is re-connected with the game the screen control (G2) may require a slight adjustment to obtain proper black level. (the black portion of picture just extinguished). To obtain colour tracking and black level cutoff.

4.0 Size adjustment and centering

4.1 Refer to figure 1 for location of the vertical and horizontal size and centering controls (4 controls).

4.2 Switch generator to the cross hatch pattern.

4.3 Adjust the centering controls so that the center lines cross at the exact center of the CRT.

4.4 Adjust the size controls so that the cross hatch pattern measures 10.5" vertically and 14.5" horizontally.

5.0 Focus

Adjust focus control for best overall definition and picture detail on an average signal applied. (Highlights should be favoured.)

6.0 E.H.T. Alignment

6.1 After 10 minutes warm up, adjust voltage regulator for 100V, -6V + 2V via R945. Measurement is made between anode of D902 and ground.

6.2 Jumper TP1 to ground with jumpers hook up oscilloscope to collector of Q902 and adjust R918 for duty cycle of ≈ 20 usec on ≈ 35 usec OFF.

6.3 Adjust R917 for anode voltage of 21 KV \pm 300V then remove jumper at TP1 and adjust R933 for 0V \pm 15 MV at TP1.

NOTE: Adjustment made with zero beam current.

7.0 X-Y Color Service Generator for G08 Monitor

Electrohome has developed a X-Y color service generator that is specifically designed for use with the G08 color X-Y monitor. It provides the monitor with the correct X, Y and video signals for 3 patterns.

- 1) Fine cross-hatch pattern.
- 2) Grey scale bars
- 3) Complete field

Three color selection switches, red, green and blue, provide the ability to display the above patterns in the three primary colors as well as the three secondary colors.

This product may be ordered from:

ELECTROHOME (U.S.A.) LIMITED
250 Wales Avenue
TONAWANDA, New York 14150
Telephone: (716) 694-3332



C.R.T. P.C.B. COMPONENT LAYOUT

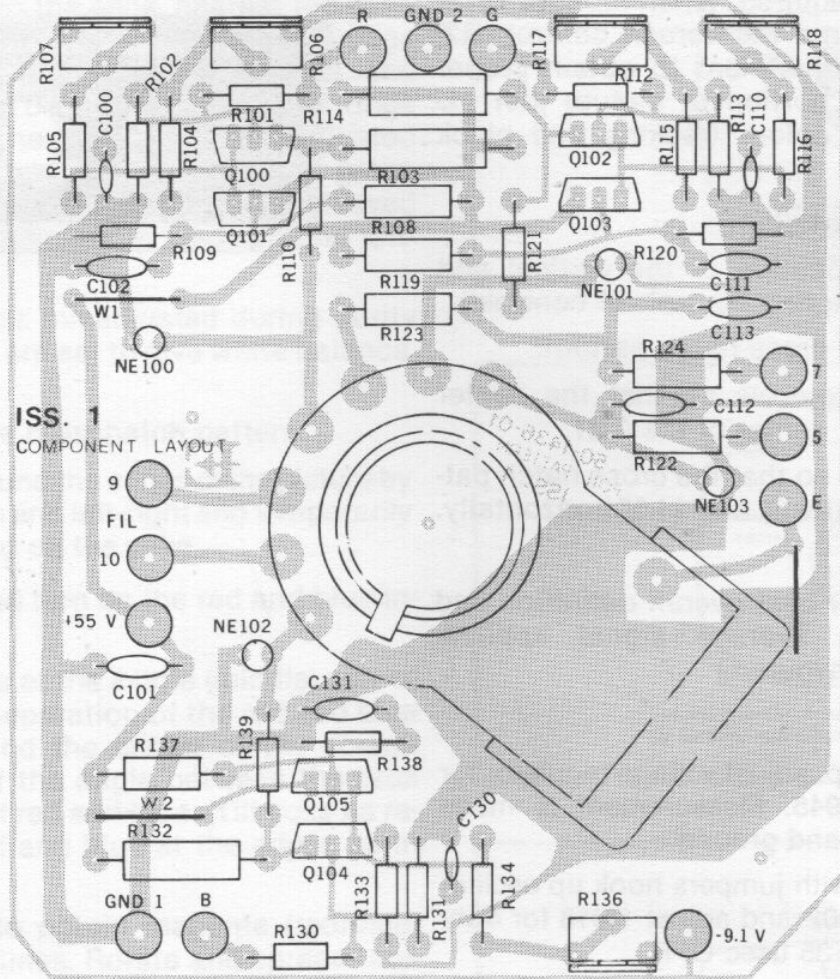

EHT P.C.B. COMPONENT LAYOUT

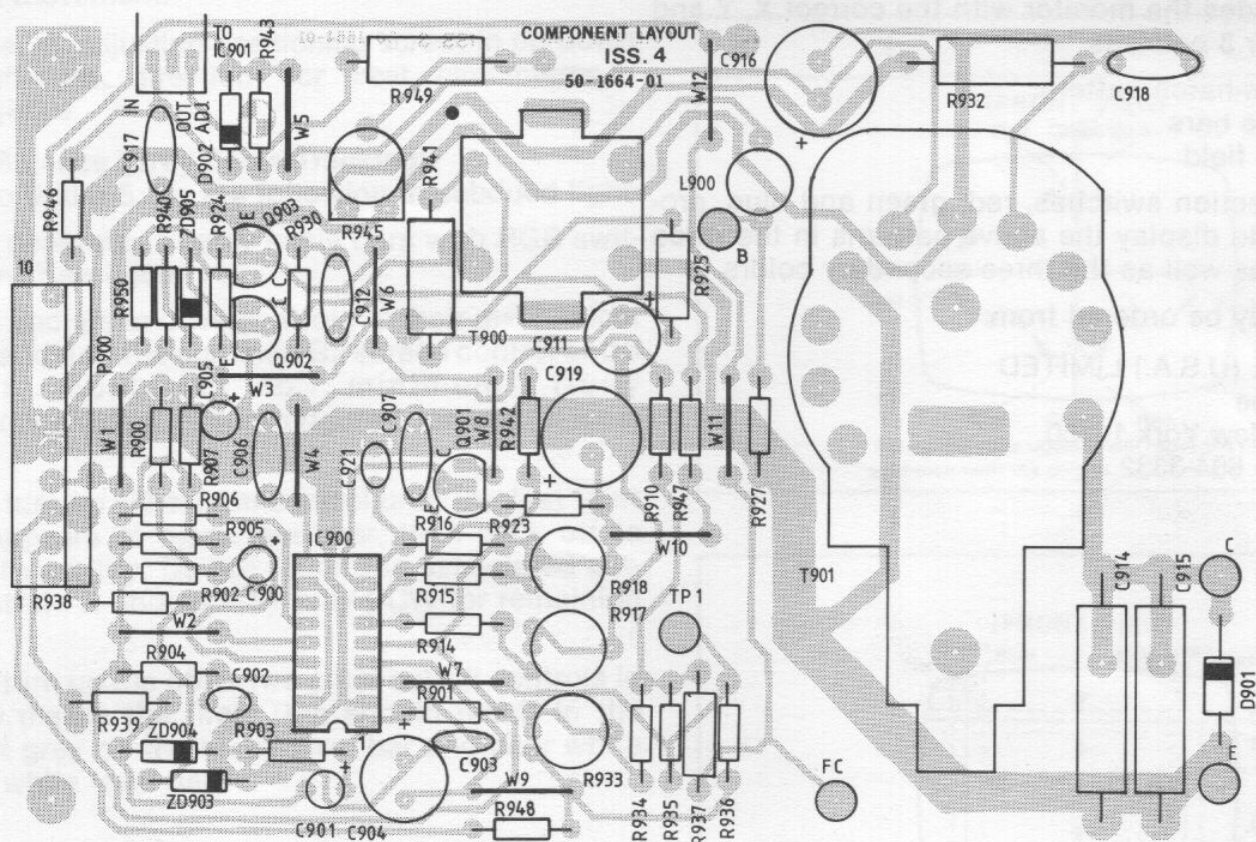

X-Y P.C.B. COMPONENT LAYOUT

10-2889-08

COMPONENT LAYOUT

ISS. 4
50-1665-01

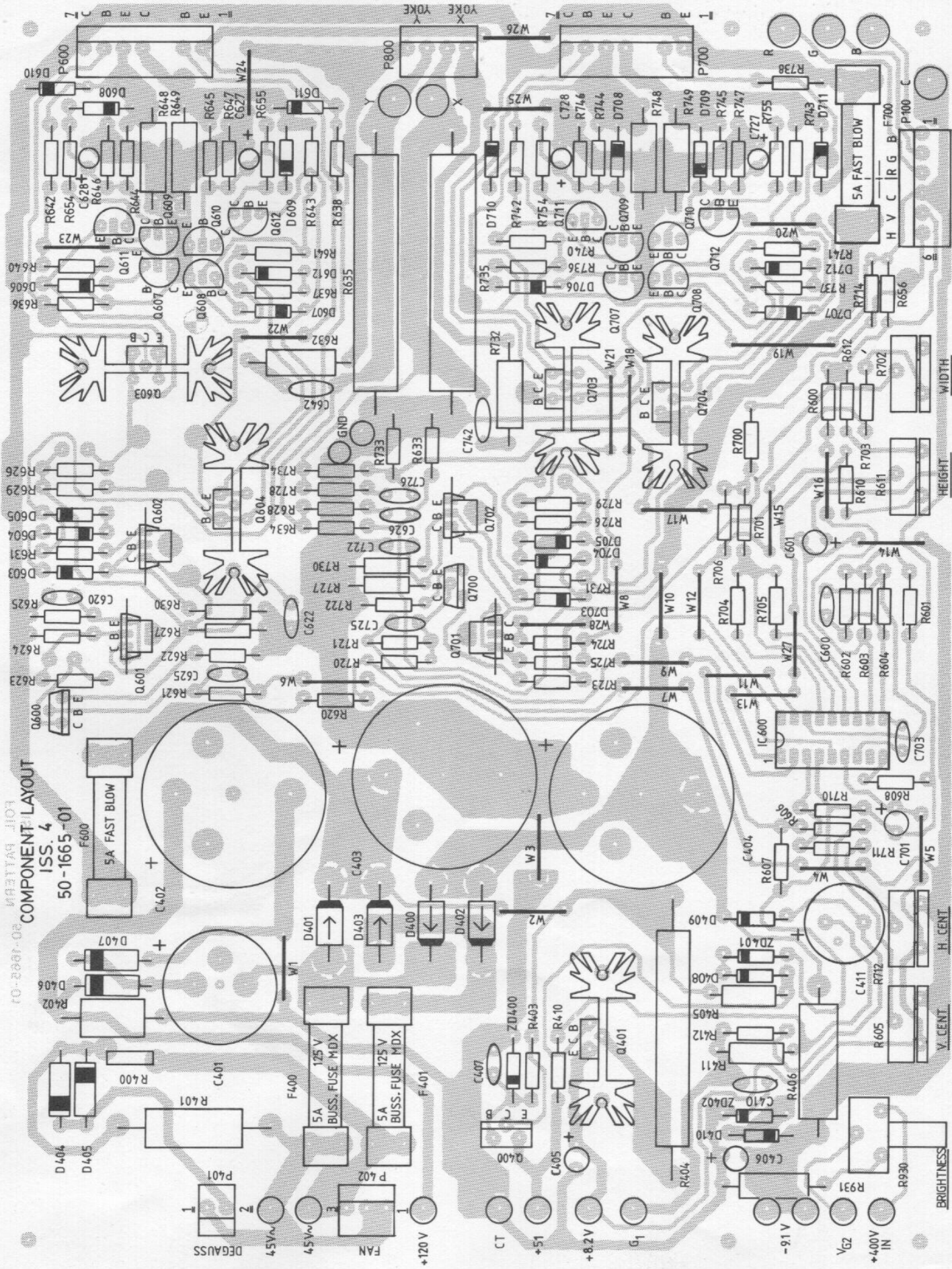

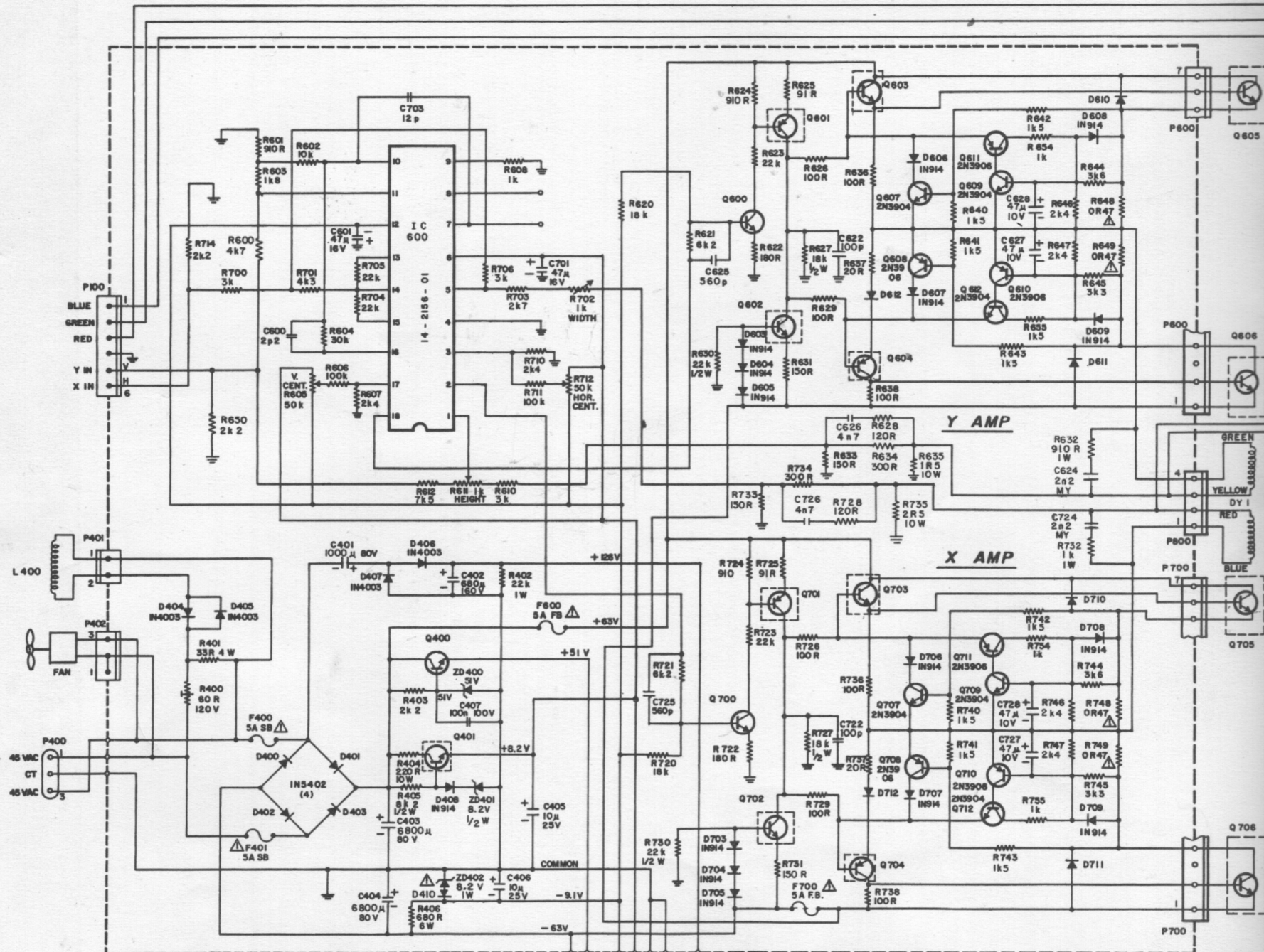

NOTES.

RESISTANCE - RESISTANCE IN OHMS (R) K (KILOHMS), OR M (MEG OHMS)
1/4 WATT, 5% TOLERANCE UNLESS OTHERWISE NOTED.

CAPACITORS - CAPACITY IN P (PICOFARADS) N (NANOFARADS), OR
μ (MICROFARADS) D.C.V. AND TOLERANCE NOTED WHERE CRITICAL.

FOR SAFETY PURPOSES (AND CONTINUING RELIABILITY)
REPLACE ALL COMPONENTS MARKED WITH SAFETY SYMBOL  WITH
IDENTICAL TYPE.

